



Lima Diesels

The ModelTorque re-motor Kit MLF-05 is designed to replace worn or under-performing Lima 'pancake' motors fitted to diesel outline locomotives.

Problems such as gear wear and binding, faulty power pickups and dirty wheels are not rectified by the fitting of an MLF-05 Kit.

We recommend that, when you purchase this kit, you also invest some of your time in attending to the above areas to ensure that the new motor will provide optimum performance of your locomotive. Please read details of our Premium Fitting Service as a basis for your work in this area.

The ModelTorque re-motor Kit is designed to fit all types of Lima 'pancake' motor bogie wheel & gear configurations, including 4 wheel & 6 wheel x 11mm dia; and 6 wheel x 14mm dia. in both 4mm/OO and 3.5mm/HO scales.

Product Upgrade.

The ModelTorque Lima re-motor kit has been upgraded to Product Code MLF-05.1.

Upgraded Product Code MLF-05.1 will be shipped from 15th August 2004.

Please review the Document "MLF-05.1 Lima Re-motor Kit Upgrade" that explains the details of, and the reasons for, this Upgrade.

The following instructions have been upgraded to reflect the upgraded product.

Installation Instructions for Product Code MLF-05.1

Guidance Notes

Step 1 : Preparation.

- 1.1 Remove loco shell,
- 1.2 Un-solder the power leads from the motor terminals,
- 1.3 Remove the support moulding from the bogie underside,
- 1.4 Remove bogie from chassis,
- 1.5 Remove 2 screws securing Lima motor,
- 1.6 Remove Lima brush-holder plate and slide armature out from the housing,
- 1.7 Insert a small screwdriver between the motor moulding and the metal ring, then ease out & remove the ring/magnet assembly,
- 1.8 Test smooth running of Lima gear set.
Place bogie on a section of straight track, and with very light pressure on the bogie top roll the bogie back & forth.
- 1.9 If the Lima gears and bogie wheels rotate freely, proceed to Step 2.
- 1.10 If the Lima gears and bogie wheels do NOT rotate freely ... STOP HERE ... clean gears.
Then repeat 1.8 & 1.9 (above) until free rolling is achieved.

1.5 & 1.6

Remove these 2 screws
Then lift off brush-holder plate

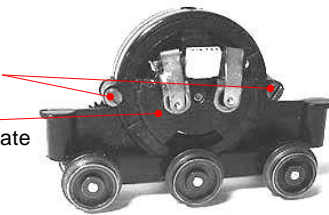

1.6

Slide armature out from housing

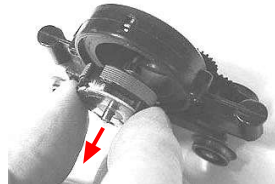

1.7

Insert small screwdriver blade between the plastic case and the metal ring (1.7a)
Lever ring/magnet assembly out of housing (1.7b), then remove (1.7c)

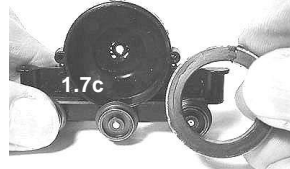
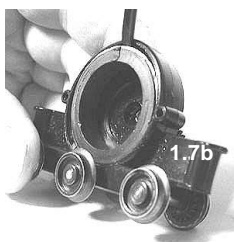
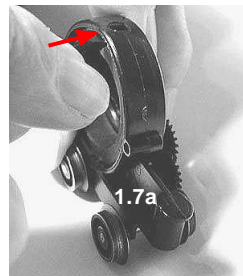

1.8

With VERY LIGHT finger pressure, test smooth running in both directions

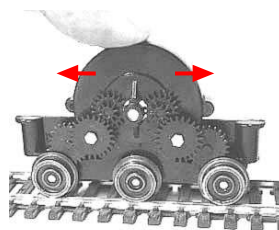

Step 1 : Preparation.

- 1.1 to 1.4 :
Take care and be observant during these steps, as you will need to repeat them in reverse when you reassemble your Loco.
- 1.5 & 1.6 :
Retain the securing screws for use with the new motor. Also, take care when you remove the brush-holder plate, as the brushes and pressure springs will drop out.
- 1.7 :
To lever-out the metal ring and magnet (1.7b), the plastic moulding must be raised sufficiently to enable the metal ring securing lug to be free of its locating hole.
The moulding is somewhat pliable - it will not snap under light pressure.
- 1.8 to 1.10 :
The intention here is that if there are existing gear or running problems, these need to be rectified before fitting your new MLF-05. If you don't, your new Kit will not perform as we say it will.
We recommend that you remove the gears, clean them thoroughly and lubricate them, preferably with ceramic grease, but good quality model oil will do.
Check drive tyres and replace if necessary; remove pick-up contact plates from both powered and non-powered bogies and clean thoroughly; clean axles and the non-powered bogie contact peg and slider clip contact; clean the rail-contact faces of all power pick-up wheels.

Installation Instructions for Product Code MLF-05.1

Guidance Notes

Step 2 : Fit gear/bearing shaft

2.1 Insert ModelTorque gear/bearing shaft through the Lima motor bearing,

2.2 Place steel washer over gear inside motor cavity and push gear/bearing assembly into housing until bronze bearing is flush with casing.

If the Modeltorque bearing is a 'press-fit' in the moulding, proceed to 2.4.

If the bearing is NOT a 'press-fit' follow 2.3 to secure the bearing with glue (supplied in Kit).

2.3 Using the glue supplied, lift a small drop from the satchel and smear around the inside edge of the bearing support hole.

Repeat 2.2 to install gear/bearing shaft, set aside for about 2 minutes to allow glue to set firmly, then proceed to 2.4

2.4 Apply ceramic grease (or model oil) to both gears on the new shaft.

2.5 Repeat 1.8 to check for smooth running of the gear/bearing shaft.

2.6 If the Lima bogie rolls freely, proceed to Step 3.

2.1

Insert gear/bearing shaft

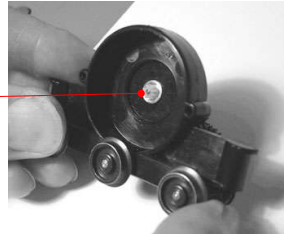

2.2

Place washer over new gear ...

and push until bearing is flush with casing

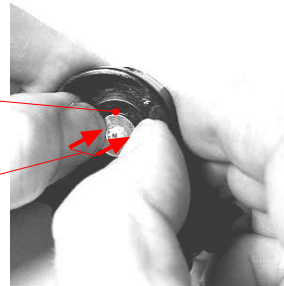

2.3

Smear ModelTorque adhesive around the inside edge of the bearing support hole; then push bearing into hole as per instructions.

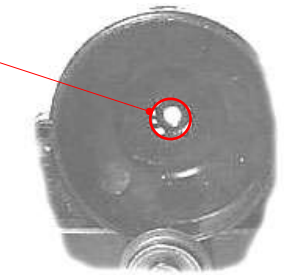

Step 3 : Fit & align new motor

3.1 Measure thread length of screws removed in 1.5, above. If the thread length is greater than 6mm ... fit a nylon washer to each screw. If the thread length is less than 6mm don't fit the nylon washer.

3.2 Insert the screws through the motor mounting bracket holes, then fit a star washer to each screw behind the bracket.

3.3 Place motor into motor cavity and locate bracket securing screws over moulding screw holes. Move the LHS of the bracket up so the LHS securing screw is at the bottom of the slot and tighten both screws by about 2 turns.

3.1

Place motor into motor cavity

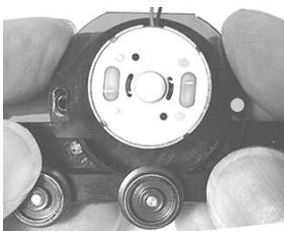

3.2 & 3.3

Insert securing screws through bracket & fit star washers before locating motor over motor cavity. Lift LHS of bracket 'till screw is at bottom of slot ... Then nip-up screws by about 2 turns

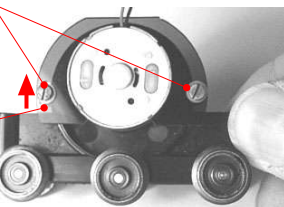

Step 2 : Fit gear/bearing shaft

2.1 to 2.3 :

The nickel-plated shaft is designed to fit securely into the existing Lima bearing fitted to the plastic moulding. Insert the ModelTorque gear/bearing shaft through the motor cavity into the existing bearing.

The new bearing is designed as a press-fit into the plastic moulding however it has been noted that the diameter of the bearing hole varies, and if the bearing slides into the hole, glue must be used to secure it.

To ensure that the new bearing is flush with the inner face of the plastic moulding, use the washer (supplied in kit) as the tool to insert the gear/bearing assembly to the correct depth. In this location, the new pinion meshes correctly with the existing drive gears.

2.4

Lubrication of gears (new + existing Lima set).

We recommend ceramic grease, however a good quality model oil will

Step 3 : Fit & new motor

This is most important part of fitting an MLF-05 to your locomotive.

3.1 & 3.2

Again, variations have been found to exist in the Lima motor cavity mouldings, and to overcome these variations additional washers are supplied to be fitted to the bracket securing screws between the rear side of the motor support bracket and the Lima motor cavity.

Installation Instructions for Product Code MLF-05.1

Guidance Notes

3.4 Move the LHS of the bracket downwards until the centre of the securing screw head is about 4mm above the bottom of the slot and secure bracket in this position by tightening both screws lightly.

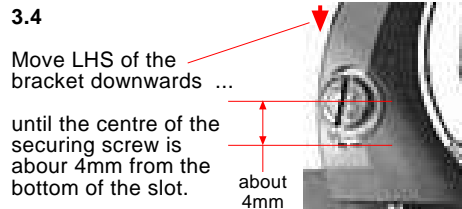

3.5 Test smooth running of new motor assembly. Place bogie on a short length of straight track and roll bogie back & forth.

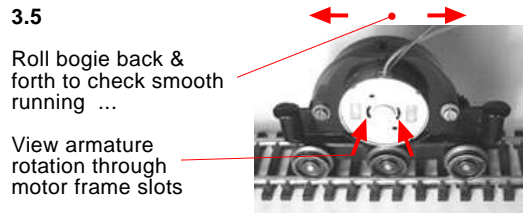

Ensure that motor pinion is engaged with drive gear by viewing motor armature rotation through slots (see photo).

If possible, use the procedure outlined in the block at right to confirm the correct motor fitting.

If assembly operates smoothly, proceed to Step 4 or Step 5.

If assembly does NOT roll smoothly follow 3.6 to achieve smooth operation.

3.6 Loosen LHS bracket securing screw, raise or lower bracket and re-tighten screw. Repeat Steps 3.4 & 3.5 until smooth rolling is achieved.

3.5
Using instruments to check motor installation

If you have the following test equipment - a variable DC power supply, a DC voltmeter & DC ammeter - you may wish to carry-out the following tests prior to re-installation of the re-motored bogie. They are not, however, an essential part of the installation.

Connect DC power to the 2 motor leads by way of flying leads. Set the voltage to about 2 Vdc [about 15% throttle]. The bogie should move smoothly and quietly at low speed, drawing no more than 100mA current.

Reverse the power supply polarity and check for smooth operation in the opposite direction. Re-adjust the motor bracket position if necessary to achieve this result, finally tightening both LHS & RHS bracket securing screws.

Step 4 : Fit speed limiter (optional)

4.1 Solder either of the diode block leads to the brass clip retaining the non-powered bogie.

Then connect the other end to the new motor as detailed in Step 5.

Step 5 : Connect motor wiring

Select from the following options:

5.1 If the Lima power bogie is fitted with 2 large gears secured by a spring clip : Connect the motor RED wire to the lead from the speed limiter connected to the non-powered bogie power clip; and the BLACK wire to the powered bogie power pick-up, or ...

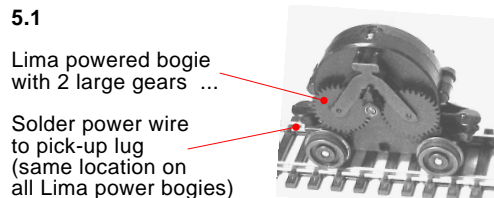

5.2 For all other Lima gear sets, connect the BLACK wire to the non-powered bogie; and the RED wire to the powered bogie power pick-up, and ...

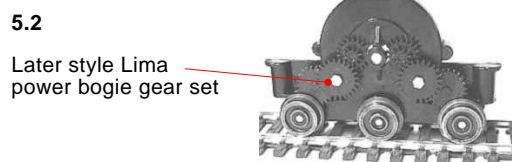

5.3 If the loco has an extra power pick-up on the non-powered bogie (with a wire through a slot in the chassis), connect this wire to the power pick-up on the powered bogie.

3.4 & 2.5

The motor is designed to fit directly above the new gear/bearing shaft and correct meshing of the motor pinion and the drive gear is very important.

If they are set too far apart you may encounter noise, slippage or no drive at all.

If they are set too closely together you may encounter excessive noise and a drop in performance or no movement at all.

Very minor adjustments of the LHS bracket securing screw position in the slot make the difference between the gears being too loose, too tight and just right.

The procedure for achieving the correct gear meshing is by feel, and trial operation listening for the soothest running ... there is no visual path to assist you.

If you have the test instruments available, the procedure outlined in the block at left offers an alternative to adjustment by 'feel' only.

Step 4 : Fit speed limiter (optional)

Fitting this item is optional. Fitting is recommended for all main-line locos; but for shunters, the lower starting voltage without the limiter may be an operating advantage. This is an individual modeller's choice.

Step 5 : Connect motor wiring

For forward movement of your loco, the RHS rail (viewed from the Driver's cab) must be positive. Lima locos pick-up the positive rail power on the rear (un-powered) bogie. The negative power pick-up is on the front (powered) bogie.

Because the different Lima gear arrangements (see photos) require the drive motor to rotate in opposite direction to move the loco forward, the motor wiring is reversed.

Some Lima locos have an second pick-up on the un-powered bogie that provides an additional connection to the negative rail. The wire connected to this pick-up should be connected to the powered bogie pick-up.

Installation Instructions for Product Code MLF-05.1

Guidance Notes

Step 6 : Re-fit bogie to chassis

Select 1 of the 2 following options:

Option 1 : 4mm/OO scale.

6.1 Feed bogie trough chassis, then secure (reverse of Step 1.4, above)

Option 2 : 3.5mm/HO scale.

6.1 Reduce the width of the bogie support lug to 1.5mm and chamfer ends to about 45° (see illustration)

6.2 Feed bogie trough chassis, then secure (reverse of Step 1.4, above)

6.2 (3.5mm/HO scale only)

Reduce the width of this bogie support lug by filing to the dimension shown

Powered bogie chassis cavity (view from top)

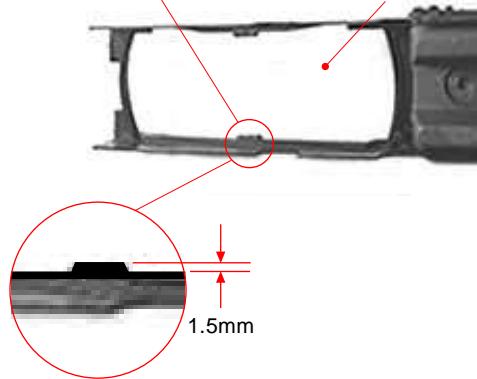

Step 6 : Re-fit bogie to chassis

The Lima 3.5mm/HO scale chassis are narrow (compared with the 4mm/OO chassis).

To ensure that the operating radius of the loco is not restricted, it is necessary to reduce the width of the motor-side bogie support lug by about 1mm. Gentle filing will do this easily.

This space is reserved for additional loco wiring diagrams